

Assessment of Combustion Modes for Internal Combustion Wave Rotors

M. R. Nalim¹

National Research Council,
NASA Lewis Research Center,
Cleveland, OH

Combustion within the channels of a wave rotor is examined as a means of obtaining pressure gain during heat addition in a gas turbine engine. Three modes of combustion are assessed: premixed autoignition (detonation), premixed deflagration, and non-premixed autoignition. The last two will require strong turbulence for completion of combustion in a reasonable time in the wave rotor. The autoignition modes will require inlet temperatures in excess of 800 K for reliable ignition with most hydrocarbon fuels. Examples of combustion mode selection are presented for two engine applications.

Introduction

The internal combustion wave rotor is a promising means of pressure-gain combustion. It approaches the thermodynamic ideal of constant-volume combustion, and can provide significant enhancement of gas turbine engine performance and NO_x emissions reduction. Pressure-gain combustion has been a long sought ideal. Indeed, the earliest working gas turbines had valved, pulsating combustion chambers (Foa, 1960). But while they encountered analytical obstacles and turbine flow unsteadiness, improvements in compressor technology favored the simpler, high loss, steady flow combustor. Over the years, a variety of methods have been investigated for pressure-gain combustion or compound-cycle systems with substantially steady flow to the turbine. These include pulse or valved combustors, detonation-wave combustors, wave rotors, and piston devices (Goldstein et al., 1957; Kentfield et al., 1988). Figure 1 includes a flow schematic of the concept and a T-S diagram to illustrate that constant-volume heat addition (2–3), yields a cycle with greater potential work output (3–4) than a conventional cycle (1–2–3'–4') with the same turbine inlet temperature (TIT).

The wave rotor arguably offers the closest viable approach to this thermodynamic ideal. Simple pulse combustors have passive or no valving to control the flow and have limited pressure gain potential. On the other hand, piston machines offer tight flow control and large pressure ratios, but are mechanically complex, bulky, and heavy. A well-designed wave rotor can provide large-amplitude pressure waves and active flow control, and will be a light, compact, low-loss device with a single low-cost moving part.

Wave Rotor Background. The wave rotor is a device that utilizes unsteady waves to exchange energy directly between fluids. It consists of a number of channels arranged about an axis; by rotation the ends of the channels are periodically connected to higher and lower pressure manifolds that generate and utilize waves in the channels. The flow in the manifolds is steady, and is directed to other steady flow components. An important feature is that as varying temperature gases flow through the rotor, it experiences a mean temperature much lower than the peak cycle temperature. Low rotational speed relative to turbomachines, and simpler geometry moderates structural and material requirements.

Among its many applications (Shreeve and Mathur, 1985), the wave rotor in a gas turbine engine can increase its pressure ratio and peak cycle temperature beyond the limits of turbomachinery. It can utilize external (i.e., conventional, steady flow) combustion or internal (on rotor) combustion. This distinction is made with reference to the wave rotor; in the thermodynamic sense, combustion is always internal, i.e., within the working fluid. Past approaches have generally proposed external combustion, pressure-exchanger systems (Wilson and Paxson, 1995; Resler et al., 1994; Zauner et al., 1993), where low pressure, compressor-discharge air is further compressed in the wave rotor channels by compression or shock waves. The compression work is provided by hot gas from the external combustor, which expands in the wave rotor, and is then sent to the turbine at a lower temperature than the combustor exit. This system acts as a topping stage to increase the pressure ratio and peak temperature of the engine cycle.

Pressure-Gain Combustion in the Wave Rotor. In the internal combustion wave rotor, combustion occurs within the wave channels, each channel being periodically charged and discharged as it rotates past appropriate partial-annular inlet and outlet ports. The typical combustion and wave processes are illustrated in the wave rotor sketch in Fig. 2. The inlet manifold, which conveys compressor-discharge air, has been omitted to reveal the inlet port in the stationary end plate. The outlet manifold exhausts the flow to a turbine. The advantages of internal combustion are (a) pressure gain equivalent to a pressure exchanger, but lighter, more compact, and with less ducting and associated losses and penalties, and (b) potentially low NO_x formation, because the expansion of burned gas within the rotor minimizes the residence time at peak temperature. In common with a pressure exchanger, the internal combustion wave rotor is periodically cooled by the air flow, and, thus, can tolerate high gas temperature, and it provides wave precompression of inlet air as it is brought to rest in the channel.

Previous descriptions of this concept have focused on mechanical (Lewis, 1955) and gas dynamic (Schapker, 1958) aspects, but not combustion. If successful, wave rotor combustion could provide a quantum advance in the performance of combustion engines, by combining the best of two worlds: the thermodynamic efficiency of confined combustion in the internal combustion (IC) engine, and the power density of the turbine. Whereas ideal reciprocating IC engine performance is compromised by dynamic effects at high speed operation, the wave rotor is designed to exploit dynamic (wave) effects.

Table 1 indicates the pressure rise developed with adiabatic constant-volume combustion of some fuel/air mixtures at various initial conditions, calculated using equilibrium chemistry

¹ Presently at the Department of Mechanical Engineering, IUPUI, 723 W. Michigan Street, SL 260, Indianapolis, IN 46202.

Contributed by the Internal Combustion Engine Division and presented at the 31st Joint Propulsion Conference, San Diego, CA, July 1995. Manuscript received by the ASME Headquarters June 12, 1998. Associate Technical Editor: D. Assanis.

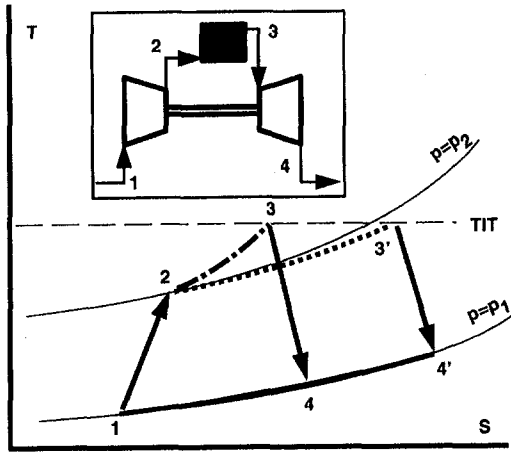

Fig. 1 Pressure-gain combustion engine cycle

and real-gas thermodynamic data. Note that the initial temperature strongly influences the pressure ratio. For simplicity, the T-S diagram of Fig. 1 ignores the necessary flow work of charging and discharging the combustion chamber(s). With accounting for flow work, the net pressure-gain ratio for a perfect constant-volume combustor (Nalim, 1998) is

$$\Pi = \Theta^{\gamma/\gamma-1} \{1 + \gamma(\Theta - 1)\}^{1/\gamma-1}$$

where Θ is the overall temperature ratio, and γ is the specific heat ratio (assumed constant). Π is less (Fig. 3) than the pressure ratio indicated in Table 1. This result must be further modified to account for nonconstant-volume combustion and wave pre-compression. Using numerical simulations that include these corrections and all major losses, Wilson and Paxson (1995) estimate that an optimized pressure-gain wave rotor can increase the specific power of a typical small gas turbine by 23 percent and decrease its fuel consumption by 19 percent. Similar performance is predicted by numerical simulation of internal combustion (Nalim and Paxson, 1997).

Wave-rotor combustion will have much in common with IC engine combustion. Fuel and air in a confined volume must react rapidly and reliably, but without damaging heat loading or pressure oscillations. Ignition and flame propagation behavior will depend on details of fuel and turbulence properties. Despite much research, diesel and spark ignited (SI) engine combustion phenomena remain poorly understood at the fundamental level; much of the empirical knowledge available may not apply beyond the specific engine conditions obtained.

Rapid combustion is essential to minimize residence time and rotor size. The peak flame speed in an automotive SI engine

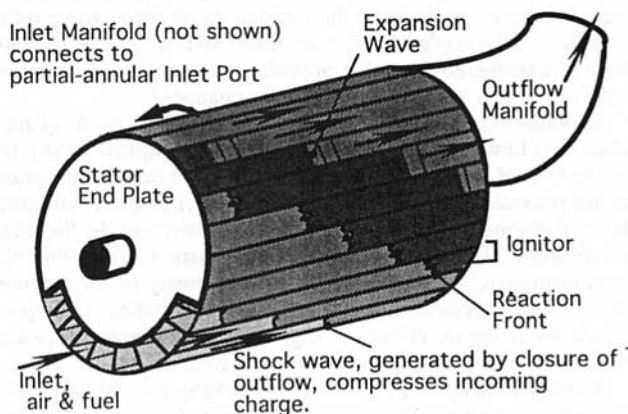

Fig. 2 Internal-combustion wave rotor sketch

Table 1 Constant volume adiabatic combustion pressure ratio

Mixture:	H ₂ /Air		C ₃ H ₈ /Air	
Equivalence ratio:	1.0	0.5	1.0	0.5
<u>Initial state</u>				
298 K, 1 atm	11.3	7.4	9.3	6.3
750 K, 1 atm	4.6	3.3	3.8	2.9
750 K, 20 atm	4.9	3.4	4.0	2.9

is typically limited by turbulence levels to 10–50 m/s. In the wave rotor we must and can achieve higher combustion rates, so that the time taken for combustion is not an inordinately large part of the total cycle time. This will require judicious design of the mode of combustion based on fuel properties and the wave-rotor inlet conditions over the range of operation of the engine.

Combustion Modes

A novel combustion system introduces many uncertainties about possible reaction initiation, propagation, and extinction mechanisms. Varying inlet conditions modify the relative roles of chemistry, molecular diffusion, turbulence, radiation, multi-phase, wall surface, and catalytic effects. For discussion, we distinguish among several typical modes of combustion of fuel and air, involving either premixed or non-premixed combustion, and different ignition mechanisms. A real combustion system may have features and behavior that combine more than one of the following idealized modes.

1. Shock-wave compression autoignition followed by a premixed reaction front, which strengthens and accelerates the shock. It may be a "fast flame" (Clarke, 1989), or develop into a detonation. This mode will require high initial temperature.
2. Premixed turbulent deflagration, when thermally ignited by a spark, laser, recirculated hot gas, or other means, at one or more sites. As in IC engines, flame speed will depend on turbulence intensity and scales, and on combustion temperature. Subsequent autoignition may accelerate combustion.
3. Autoignited non-premixed combustion when fuel is injected into air at (or immediately compressed to) sufficiently high temperature, as in a diesel IC engine. Some

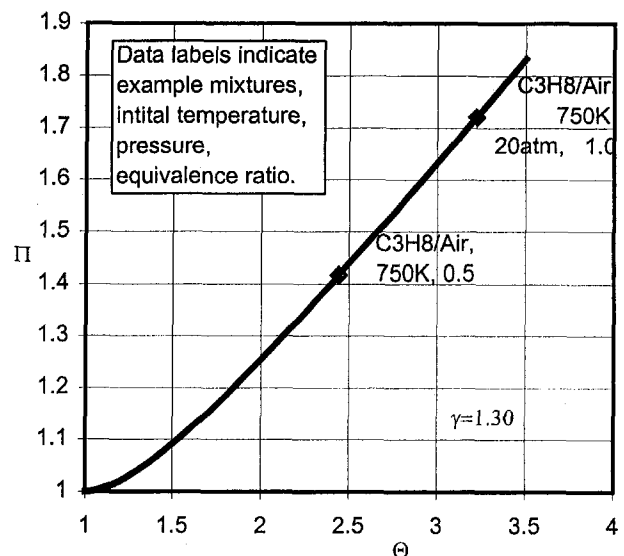

Fig. 3 Constant-volume combustion pressure gain

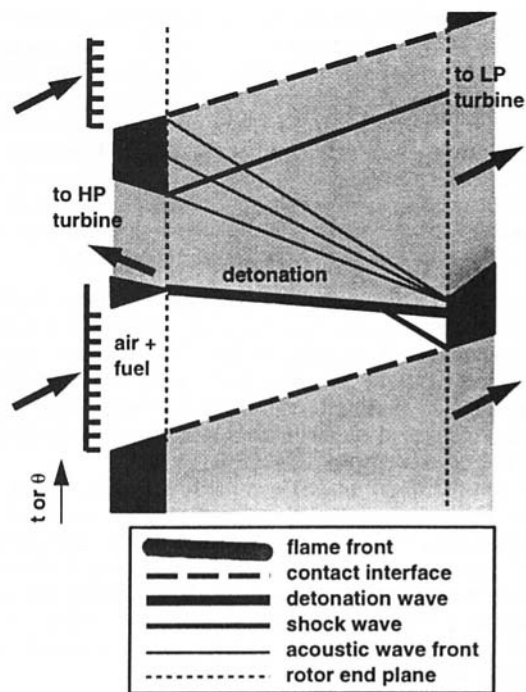

Fig. 4 Simplified wave diagram for shock-ignited detonation mode

contiguous fuel and oxygen mix and rapidly autoignite; the remainder react at a rate determined by turbulent mixing. The unsteady flow process within the wave rotor is best illustrated by a wave diagram. This is a position–time ($x-t$) diagram (or time history) of the periodic process in any single channel. The vertical axis represents time t . Figures 4 and 5 are simplified wave diagrams for premixed modes. Full lines represent the trajectories of pressure waves, and broken lines represent the paths of fluid particles or interfaces. When inlet temperature is sufficiently high, the mixture will react behind the shock, ultimately forming a detonation (Fig. 4). With lower temperature, deflagrations must be initiated, possibly from each end (Fig. 5). For pressure gain, the outlet pressure is higher than the inlet pressure, unless there is a second exhaust to a low-pressure (LP) turbine (Fig. 4). Thus, the hot gas in the channel from the previous cycle may not be completely purged and could be a useful ignition source (but beware of flashback as discussed later).

Premixed Autoignition and Detonation. Fuel properties and temperature primarily determine whether compression ignition can occur. Gaseous hydrocarbon-air mixtures at 600–900 K autoignite in a two-stage chemical process involving a “cool flame” (Halstead et al., 1977). Empirically, an autoignition delay time for a particular fuel/oxidant mixture is determined at given temperature and pressure conditions. At fixed conditions, the chemical autoignition time varies among common hydrocarbon fuels by about an order of magnitude. Small amounts of certain compounds (e.g., octane boosters in gasoline) can strongly affect autoignition in otherwise identical compositions. Autoignition delay times have been measured in a variety of experimental reactors: rapid compression machines (Halstead et al., 1977), shock tubes (Burcat et al., 1971), combustion bombs, and continuous plug flow ducts (Freeman and Lefebvre, 1984; TeVelde and Spadaccini, 1981). Comparable values vary significantly and there is disagreement about the relative influence of reaction variables (such as stoichiometry). Ignition delay data must be interpreted carefully in the light of fuel specifications, experimental apparatus, and detection criteria. A sample of compiled data is presented in Fig. 5, scaling the autoignition

time with the inverse of pressure to allow a reasonable comparison among experiments over a wide range of conditions.

Referring to Fig. 4, with nearly sonic inflow, the temperature will rise by a factor about 1.4 through the shock wave that stops the flow. For a 900 K hydrocarbon-air mixture adiabatically compressed to 1250 K, the chemical induction time will contract from a few milliseconds to about 0.01 ms. In comparison, the acoustic transit time will be about 0.5 ms for a half-meter long channel. For these conditions we expect immediate reaction behind the shock to form equilibrium products. When post-compression temperature is below about 1100 K, the chemical time scale will be finite relative to the acoustic time scale. For even lower temperatures (<600 K) hydrocarbon autoignition reactions are typically negligible.

Relative to the inflowing mixture, the far end plate is equivalent to a suddenly started piston. The relative velocity and the reaction enthalpy together determine whether an overdriven or a Chapman–Jouguet (C-J) detonation occurs. C-J detonation speeds for lean propane-air mixtures range 1500–2500 m/s for pressures of 1–20 atm, with weaker dependence on stoichiometry and temperature.

Detonative combustion produces a severe pressure pulse and hot, high speed flow behind the wave. Although the peak heat load is momentary and is offset by colder flows, the weight and cost of an adequately robust rotor is unknown. Another drawback is the temperature and composition sensitivity of autoignition already discussed. When inlet temperature is low (e.g., at startup), an alternative ignition method is required.

Premixed Deflagration. Turbulent flame propagation is necessary for fast burn in this mode, as in the SI engine. Sources of turbulence generation in the inflowing gas include the upstream compressor, ducting, fuel spray, the opening process, any additional turbulence generators, and the stopping shock. On board, the turbulent kinetic energy will be distributed into length scales no larger than the characteristic channel transverse dimension, b .

Since ignition can occur as soon as the inlet closes, turbulence decay is limited. (In contrast, reciprocating-engine turbulence decays considerably during piston compression, and various means—squish, swirl, tumble—are employed to enhance turbulence.) If the root-mean-square turbulence intensity is u' , and the characteristic lengthscale of turbulent eddies is assumed equal to b , their characteristic timescale will be b/u' ; this is a measure of their rate of decay. The extent of decay in the intake duration t_i can be characterized by the number of eddy rotations $n_d = t_i u'/b$. For small inlet Mach no. M_i , it can easily be shown

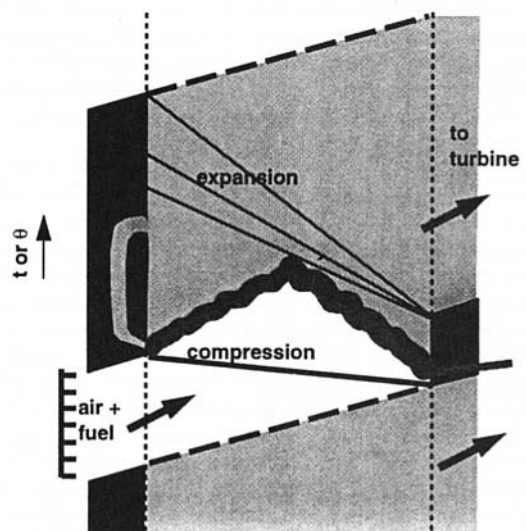

Fig. 5 Simplified wave diagram for deflagration mode

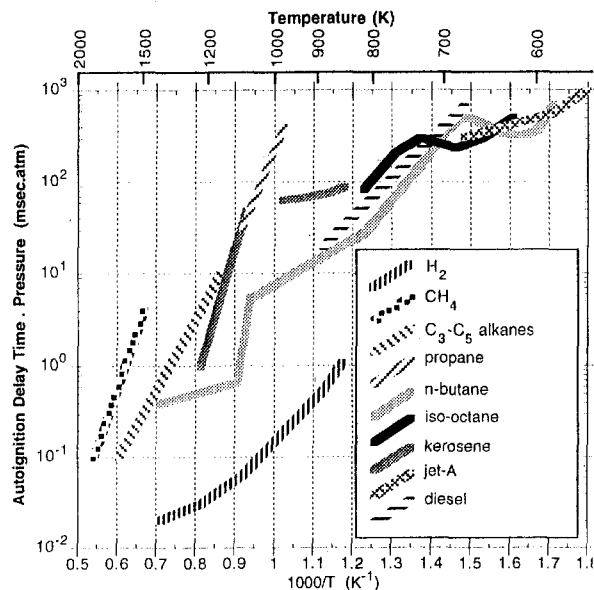

Fig. 6 Autoignition delay for common fuels (Halstead et al., 1977; Burcat et al., 1971; Freeman and Lefebvre, 1984; TeVelde and Spadaccini, 1981; Slack and Grillo, 1977; Ohta et al., 1987)

that $n_d \cong (u'/U_i)(L_d/b)(1 + M_i)$, where L_d is the filled length of the channel and U_i is the inlet velocity. For typical values of $L_d/b = 10$, $u'/U_i = 0.1$, $M_i = 0.3$, there is about one rotation, and, therefore, little decay.

Turbulent combustion can occur in a variety of regimes ranging from wrinkled laminar flames to distributed combustion. When a propagating flame can be defined, the turbulent flame speed, s_t , depends on both turbulence properties and chemical kinetics. Measurements of s_t in some experiments (reviewed by Heywood, 1988) indicate that s_t is about equal to u' for moderate levels of turbulence up to twenty times the laminar flame speed, s_l . If the inlet Mach number is 0.3 and u'/U_i is 0.1, the effective flame speed is about 3 percent of the acoustic speed at inlet conditions. Increasing the turbulence intensity should boost the flame speed, but there is little data about flame propagation at very high intensities.

Ignition of a premixed gas could be by a spark, laser, recirculated or residual hot gas, or other means. Spark-ignition delay time will be governed by laminar flame kinetics until the initial flame kernel reaches the size of the turbulent eddies. Multiple or distributed ignition sites would reduce ignition delay and combustion time. Recirculation of high-pressure combustion gas from leading channels via a passage in the end wall (Fig. 5) can provide penetrating jets of hot gas for fast reaction. With proper mixture control, residual gas can provide another strong ignition source.

Limitation of TIT necessitates an overall fuel-air ratio that is considerably leaner than stoichiometric (equivalence ratios of 0.3 to 0.4). This cannot support ignition and flame for typical inlet temperatures. Lean-burn IC engines use charge stratification for reliable ignition, with the spark region nearly stoichiometric to minimize ignition delay and required ignition energy. The wave rotor charge can be easily stratified by nonuniform fuel distribution, but this may result in outflow temperature nonuniformity. Homogenization of temperature in the channel and downstream requires further investigation.

As in SI engines, autoignition can occur in the "end gas" that burns last. Some precombustion reactions normally occur as temperature rises by compression. If this causes autoignition before the flame arrives detonation may occur. Stratification for lean end gas can prevent autoignition without resort to high octane fuel.

Risks of premixing are premature ignition and flashback, particularly with high inlet temperature and hot casing-gas infiltration due to poor end-gap seals. However, typical inlet velocities far exceed flame speed and cause high strain rates near walls, discouraging flashback. Valving by rotation naturally separates the combustion chamber from the intake port. Premature ignition by residual gas can be controlled by tailoring the stoichiometry of the leading inlet gas. While flashback is unlikely, any combustion that occurs before confinement contributes absolutely no benefit from taking place in a wave rotor.

Nonpremixed Compression Ignition. Besides flashback, potential problems with premixing are uncontrolled autoignition/detonation and ignition failure for over-lean mixtures. Combustion could be accomplished rapidly without complete premixing if (a) high inlet temperature ensures short ignition delay time (physical and chemical), and (b) turbulent mixing is strong during combustion.

The non-premixed mode is similar to diesel IC engine combustion. Heat release profiles in diesel engines show that combustion occurs in two phases (Heywood, 1988): rapid combustion of fuel and air mixed before autoignition, followed by diffusion burning of the bulk of the fuel. Completion time is determined by the turbulent mixing timescale, which normally exceeds the kinetic timescale. Similar behavior is expected in the wave rotor.

High speed diesel sprays have an initial injection velocity exceeding 100 m/s, but require several milliseconds to penetrate over a few centimeters. To fully utilize the charge air and obtain good mixing, fuel should be added in the intake using multiple nozzles. A possible wave diagram for non-premixed combustion is given in Fig. 7. With continuous port injection, fuel distribution is accomplished by the flow of air rather than by spray penetration. Liquid fuel will still require high pressure injection for atomization. A likely configuration is a rail-type injector with plain orifices. Swirl orifices will not be useful unless placed some distance upstream of the inlet plane. With many injectors, the distinction from premixed combustion is admittedly blurred. For liquid fuels with good atomization we can neglect the physical delay time for a small amount of fuel to evaporate and mix. The chemical ignition time with most hydrocarbon fuels will not exceed 1 ms for conditions beyond 1000 K and 30 atm (Fig. 6). Limited by decaying cylinder turbulence, the total burn duration in today's high-speed diesels can be several milliseconds. In the wave rotor, turbulence will be intense and sustained.

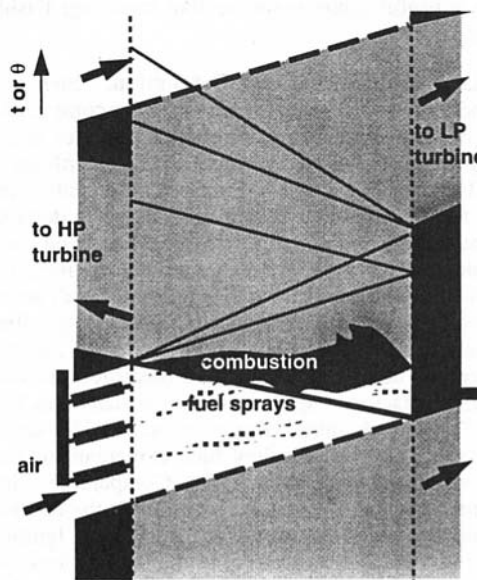

Fig. 7 Simplified wave diagram for non-premixed mode

Table 2 Engine and wave rotor design data (Wilson and Paxson, 1995; Paxson, 1995a)

	Small engine	Large engine
<i>Base Engine</i>		
Core Mass Flow (kg/sec)	1.8	180
Shaft Compression Ratio	7	40
Turbine Inlet Temperature (K)	1330	1780
Compressor Discharge Temp.(K)	580	930
Core Air/Fuel Mass Ratio	45.8	38.6
<i>Pressure-exchange wave rotor</i>		
Rotor Diameter, Length (mm)	152, 152	610, 305
Channel Height, Width (mm)	16.2, 7.6	114.6, 9.7
Wave cycle period (ms)	1.92	3.57
Relative Inlet Velocity (m/s)	~200	~300
<i>Performance of topped engine</i>		
Pressure Gain in wave rotor	1.232	1.204
% Increase, core specific power	23	8.7
% Decrease, SFC	18.8	8.0
<i>Combustion initial and final states</i>		
T_i (K)	640	1040
p_i (atm)	9.7	55.2
T_f (K)	1580	2560
p_f (atm)	16.5	94.4

Example Design Cases

Using a validated simulation code, Wilson and Paxson (1995) optimized 4-port, pressure-exchanger wave rotors (with one exhaust port) for engine sizes from about 2 to 200 kg/s core flow. The equivalent 2-port, internal combustion wave rotors, with the same inflow and outflow states, are examined here for two of those designs. The overall performance of a topped engine depends only on these states, whether combustion is internal or external.

Table 2 indicates the relevant data for these designs. The pressure-exchange cycles for the two engines are nearly identical when nondimensionalized with respect to their inlet states. Their common wave diagram, Fig. 8, shows that the hot gas present in the channel is partially recirculated to the external

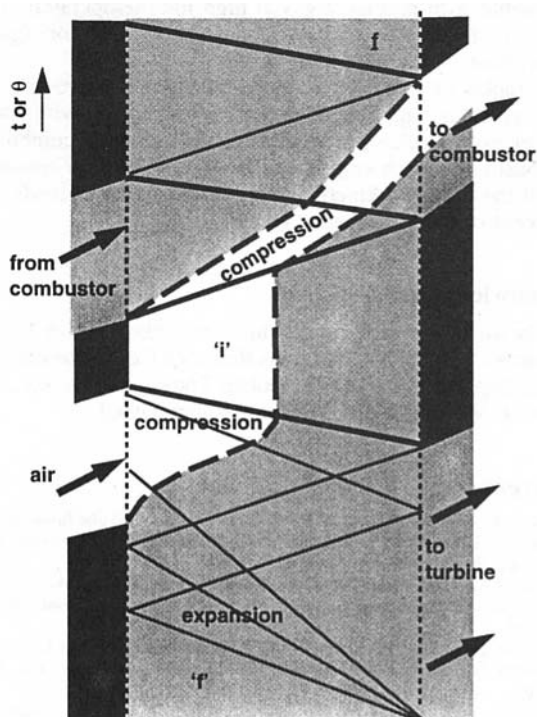

Fig. 8 Wave diagram for pressure-exchanger cycle

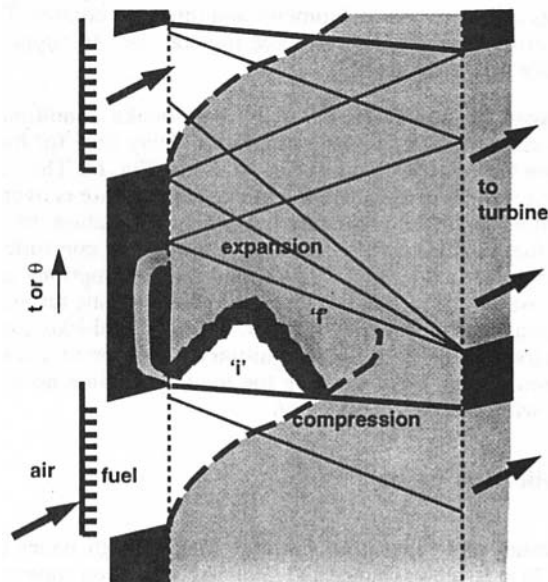

Fig. 9 Wave diagram for equivalent internal combustion cycle

combustor, because complete scavenging precludes pressure gain. Only 65 percent of the hot gas in the channel at state ‘f’ is exhausted; the mass flow through the combustor is increased 55 percent due to recirculation. After ram compression, unreacted fresh charge (state ‘i’) will occupy 45 percent of the channel.

Figure 9 is the wave diagram for an internal combustion wave rotor, which replicates the inlet and exhaust flows of the pressure exchanger. The strengths of the inlet compression wave and the exhaust expansion wave are also replicated; therefore, as are the states marked ‘i’ and ‘f’, which now represent the initial and final states of the internal combustion process. The fresh charge expands in volume by a factor of 1.4 during combustion while the pressure increases by a factor of 1.7. The actual temperatures of the initial states in the two engine designs differ greatly, dictating different combustion modes as discussed below. It is assumed that the pressure-exchanger dimensions are retained and that the fuel is a typical hydrocarbon.

Small Engine Case. Referring to Fig. 6, the autoignition delay time for the initial conditions of 640 K and 9.7 atm is about 50 ms for most hydrocarbon fuels, much longer than the 0.5 ms intake process. Therefore, only premixed deflagration is feasible, ignited by a hot gas jet at the left end wall and by residual gas on the right. The charge near the left wall is stoichiometric to ensure ignition with minimum delay. For the above initial conditions, the laminar flame speed is about 1 m/s for gasoline-like fuel. If the turbulence length scale is taken equal to the channel width (7.6 mm) the ignition delay time for a conventional electric spark is estimated to be 7 ms. This is unacceptable if the total wave-cycle time is not to exceed that of the pressure exchanger. Although a crude estimate, it is a certain indication that much stronger sources of ignition are needed, such as recirculated and residual hot gas.

If the turbulence kinetic energy in the inlet flow is assumed to be about 5 percent of the total kinetic energy (which corresponds to a drop in total pressure of about 1 percent), then $u' = 50$ m/s. At this speed, a single turbulent flame would traverse the combustible mixture (half the rotor length) in about 1.6 ms. This puts the total cycle time only slightly over that for the corresponding pressure exchanger. Although flame speed may fall off at high u' , stratification and dual ignition sites will compensate. Ignition by residual gas as-

sumes appropriate stoichiometry and interface control. There is a critical need for good experimental data to support or modify this assessment.

Large Engine Case. For the post-intake conditions of 55.2 atm and 1040 K, the autoignition delay time for hydrocarbon fuels ranges from 0.2 ms to 2 ms (Fig. 6). The intake duration is about 1 ms and the intake temperature is over 900 K. Premixing risks premature ignition or detonation. Instead, port fuel injection will allow combustion to be controlled by mixing after autoignition. With the same assumptions as the last case for the turbulence level, the characteristic turbulence timescale will be about 0.2 ms. Using diesel-like fuel, it appears feasible to complete ignition and non-premixed combustion within 2 ms, keeping the total cycle time no longer than with external combustion.

Application Issues

Design and Operation Issues. Many design issues common to pressure-exchange and internal combustion wave rotors are discussed elsewhere (Snyder, 1996; Wilson and Paxson, 1995). These include rotation speed selection and matching, alternative cycles, and off-design performance. It is evident that the concept of combustion in a wave rotor presents some unique challenges, but there are also many unexplored ideas and possibilities for design.

Stability. Compared to the pressure-exchanger cycle, on-rotor combustion and gas dynamics are closely and dynamically coupled. This creates the possibility of cycle-to-cycle variability and oscillations whose stability behavior is unknown at present. For instance, an increase in the amount of fuel in one cycle will boost combustion pressure, and thus increase the mass of air taken in during the next cycle. The evolution of this disturbance will depend partly on the fuel control system. The dynamic behavior of a pressure exchanger appears to be beneficial to a gas turbine (Paxson, 1995b), and this may be true with internal combustion as well.

Cooling. In the wave cycle of Fig. 9, the fresh charge does not completely fill the channel. Therefore, it cools only one end of the rotor, unless "reverse flow" multiple cycles are used. For example, the inlet on the left could be followed (after combustion) by an exhaust port on the left, with the inlet for the next cycle on the right. With perfect symmetry, a permanent buffer gas would remain in the rotor. Other arrangements are possible that would also provide even cooling.

Off-design. Only a single-point design is considered in the examples discussed. Over the real operating range of the engines, mixture conditions will vary considerably, affecting ignition and combustion. Guaranteed ignition at all conditions will require fuel staging (stratification), which is easily accomplished by partitioning the inlet port into zones with different steady fueling rates. Although requiring multiple manifolds, modulation of individual nozzles should allow adequate turn-down. Numerical simulation of stratified combustion over a wide load range is discussed by Nalim (1997).

Leakage. Thermal issues may be exacerbated by leakage of hot or combustible gas into the rotor-housing cavity. The control of end gaps to limit leakage is required for all wave rotors, for which workable methods have been invented. Internal combustion allows more time for leakage, possibly from hotter gas, requiring tighter control.

Life. High cycle fatigue due to pressure fluctuations may be lower than in a pressure exchanger, but remain an important mechanical design issue. Temperature fluctuations are too rapid

to be felt by the rotor, which will remain at a steady-state temperature.

Emissions. NO_x emissions are determined by combustion temperature, residence time, and stoichiometry. In a wave rotor, the residence time at high temperature can be kept short by properly timing the expansion that discharges the channel. Inlet stratification allows lean combustion overall and local enrichment at the ignition site, as in IC engines (Tice and Nalim, 1988; Resler, 1988). A wave rotor could also be designed to incorporate the rich stage of a Rich-Quench-Lean (RQL) low-NO_x combustion scheme (Nalim and Resler, 1995). The RQL scheme requires rapid mixing of hot rich-burn product and quench air, to minimize time at near-stoichiometric conditions. Large injection pressure drop and liner cooling are challenges. A rich-combustion wave rotor can provide (a) a self-cooled combustion chamber, (b) pressure exchange to quench air for rapid second-stage mixing, (c) immediate wave expansion cooling of the rich burn gases, and (d) lower enthalpy of exiting rich product gas, thus reducing mixing-zone stoichiometric temperature.

In a lean-burn wave rotor, there may be unburned hydrocarbons due to quenching in over-lean zones, but no significant carbon monoxide (CO). Pollutants usually formed under rich conditions, such as CO and soot are more likely in rich-burn and in non-premixed cycles. It is premature to make more detailed emissions predictions. Carbon dioxide emissions will always be reduced in proportion to the gain in efficiency.

Conclusions

Combustion within the channels of a wave rotor is a promising means of obtaining pressure gain in a gas turbine engine. Premixed deflagration and non-premixed combustion will require strong turbulence for completion of combustion in a reasonable time in the wave rotor. Sufficient turbulence is expected, with little decay.

For reliable ignition with most hydrocarbon fuels, premixed and non-premixed autoignition modes will require inlet temperatures in excess of about 800 K; otherwise, a supplementary ignition method must be provided. Rapid detonative combustion is possible with premixed gas at high inlet temperature, but it may complicate the mechanical design of the rotor. Ignition temperature is fuel dependent.

Examples of combustion mode selection are presented for two core engine applications previously designed with equivalent pressure-exchanger cycles using external combustion. Combustion in each engine can be completed in a reasonable time if the turbulent kinetic energy in the inflow exceeds about 5 percent of the total kinetic energy.

Acknowledgments

This work was performed while the author held a National Research Council–NASA Lewis Research Center Research Associateship, advised by Dr. L. Bober. The comments of L. Larosiere, J. Wilson, and F. Hinant are appreciated.

References

- Burcat, A., Scheller, K., and Lifshitz, A., 1971, "Shock-Tube Investigation of Comparative Ignition Delay Times for C1-C5 Alkanes," *Combustion and Flame*, Vol. 16, pp. 29–33.
- Clarke, J. F., 1989, *Prog. Energy Combust. Sci.*, Vol. 15, pp. 241–271.
- Foa, J. V., 1960, *Elements of Flight Propulsion*, John Wiley and Sons, Inc., New York.
- Freeman, G., and Lefebvre, A. H., 1984, "Spontaneous Ignition Characteristics of Gaseous Hydrocarbon-Air Mixtures," *Combustion and Flame*, Vol. 58, pp. 153–162.
- Goldstein, A. W., Klapproth, J. F., and Hartmann, M. J., 1957, "Ideal Performance of Valved-Combustors and Applicability to Several Engine Types," ASME Paper No. 57-A-102.

- Halstead, M. P., Kirsch, L. J., and Quinn, C. P., 1977, "The Autoignition of Hydrocarbon Fuels at High Temperatures and Pressures—Fitting of a Mathematical Model," *Combustion and Flame*, Vol. 30, pp. 45–60.
- Heywood, J. B., 1988, *Internal Combustion Engine Fundamentals*, McGraw-Hill, New York.
- Kentfield, J. A. C., and O'Blencs, M., 1988, "Methods of Achieving a Combustion-Driven Pressure Gain in Gas Turbines," *ASME JOURNAL OF GAS TURBINES AND POWER*, Vol. 110, p. 704.
- Lewis, R. B., 1955, "Engine Having a Rotor With a Plurality of Circumferentially-Spaced Combustion Chambers," U.S. Patent 2,705,867.
- Nalim, M. R., and Resler, E. L., Jr., 1995, "Wave Cycle Design For Wave Rotor Gas Turbine Engines With Low NO_x Emissions," ASME Paper No. 95-GT-245.
- Nalim, M. R., and Paxson, D. E., 1997, "A Numerical Investigation of Premixed Combustion in Wave Rotors," *ASME JOURNAL OF ENGINEERING FOR GAS TURBINES AND POWER*, Vol. 119, p. 668.
- Nalim, M. R., 1994, "Wave Cycle Design for Wave Rotor Engines with Limited Nitrogen Oxide Emissions," Ph.D. thesis, Cornell University, Ithaca, NY.
- Nalim, M. R., 1997, "Numerical Study of Stratified Charge Combustion in Wave Rotors," AIAA Paper No. 97-3141.
- Nalim, M. R., 1998, "Thermodynamic Limits of Pressure Gain and Work Production in Combustion and Evaporation Processes," AIAA Paper No. 98-3398.
- Ohta, Y., et al., 1987, "n-Butane Ignition in a Wide Range of Temperatures," *Progress in Astronautics and Aeronautics*, Vol. 113, p. 225.
- Paxson, D. E., 1995a, private communication.
- Paxson, D. E., 1995b, "A Numerical Model for Dynamic Wave Rotor Analysis," AIAA Paper No. 95-2800.
- Resler, E. L., Jr., 1988, "Intake Manifold Prestratified Charge," *Chem. Eng. Comm.*, Vol. 67, pp. 111–127.
- Resler, E. L., Jr., Mocsari, J. C., and Nalim, M. R., 1994, "Analytic Design Methods for Wave Rotor Cycles," *AIAA J. Propulsion and Power*, Vol. 10, No. 5, p. 683.
- Schapker, R. L., 1958, "Analysis of a Wave Combustor Designed for Time-Steady Inlet and Discharge Conditions," General Electric Company Technical Information Series No. DF58AGT 387, Flight Propulsion Laboratory Dept., Cincinnati, OH.
- Shreeve, R. P., and Mathur, A., 1985, ed., *Proceedings, ONR/NAVAIR Wave Rotor Research and Technology Workshop*, Naval Postgraduate School, Monterey, CA.
- Slack, M., and Grillo, A., 1977, "Investigation of Hydrogen-Air Ignition Sensitized by Nitric Oxide and Nitrogen Dioxide," NASA CR-2896.
- Snyder, P. H., 1996, "Wave Rotor Demonstrator Engine Assessment," NASA CR-198496.
- TeVelde, J. A., and Spadaccini, L. J., 1981, "Autoignition Characteristics of No. 2 Diesel Fuel," NASA CR-165315.
- Tice, J. K., and Nalim, M. R., 1988, "Control of NO_x Emissions in Gas Engines Using Prestratified charge—Applications and Field Experience," ASME Paper No. 88-ICE-11.
- Wilson, J., and Paxson, D. E., 1995, "Optimization of Wave Rotors for Use as Gas Turbine Engine Topping Cycles," SAE Paper No. 951411.
- Zauner, E., Chyou, Y.-P., Walraven, F., and Althaus, R., 1993, "Gas Turbine Topping Stage based on Energy Exchangers: Process and Performance," ASME Paper No. 93-GT-58.